



# On the change in surpluses equivalence: measuring benefits from transport infrastructure investments

José Meléndez-Hidalgo <sup>1\*</sup>, Piet Rietveld <sup>1</sup>, Erik Verhoef <sup>1,2</sup>

<sup>1</sup> Department of Spatial Economics, Free University of Amsterdam

<sup>2</sup> Tinbergen Institute

---

## Abstract

Reductions in transport costs resulting from infrastructure improvements generate benefits that can be measured as surplus changes either at an economy-wide scale (social welfare changes) or, as is common practice in cost-benefit analysis (CBA), at a transport market level as transport users' surplus changes. In this paper we look at an economy with spatially separated markets embedded in a transport network (a spatial price equilibrium model) to study the equivalence between these two benefit measures. Three different product market competition arrangements are considered. A similar question and strategy is presented in Jara-Díaz (1986) employing a two-node network and extreme competition assumptions on the production side: perfect competition and monopolistic production with arbitrage. We extend his work by additionally considering perfect collusion (monopoly without resale) and Cournot-Nash oligopoly under flow-dependent transport costs (i.e. congestion in transport). Numerical simulations in a three-node network with and without transshipment nodes, illustrate our main results.

*Keywords:* Cost-benefit analysis; Indirect benefits.

---

## 1. Introduction

In recent years a renewed interest has emerged on the effects arising outside the transport market when transport infrastructures are improved (SACTRA, 1999). The interest on this issue in economics can be traced back to Tinbergen (1956) where, for a three-region economy under monopolistic production, a comparison is made between transport users' cost savings and economy-wide effects (e.g. aggregate production changes) after a reduction in the cost of transportation for a pair of regions. In a related vein of research Jara-Díaz and Friesz (1982) employed a spatial price equilibrium (SPE) model to study the equivalence between the economy-wide changes in trade surplus and the transport users' benefits for a two-region economy under perfect competition in production. Their paper initiated the use of SPE models to investigate the properties of

---

\* Corresponding author: José Meléndez-Hidalgo (jmelendez@feweb.vu.nl)

an implicitly *derived transport demand*.<sup>1</sup> Jara-Díaz (1986) returned to this topic considering perfect competition and monopolistic production, the latter with the possibility of resale (i.e. arbitrage), within a two-node one-link transport network.

In this paper we further develop the analysis in Jara-Díaz (1986) and Jara-Díaz and Friesz (1982), (hereafter referred as JD and JD-F, respectively) considering different competition arrangements in production and more complex transport networks. In JD-F the equivalence between users' benefits measured on a derived transport demand and those benefits measured as economic (trade) surplus is analyzed under perfect competition. Their network equilibrium model comprises a two-region economy within a two-links (transport modes or routes) network, given that their main interest is on mode interaction when a uni-modal improvement is in place. This comparison is dubbed the *surplus equivalence problem* in JD, where more analytical detail is provided using an SPE model with two regions embedded in a single link network, under both perfect competition and monopolistic production with resale.<sup>2</sup> We will be employing similar SPE models with elastic derived transport demands and in addition to the perfect competition case will consider imperfect competition in the form of monopoly over all production sites without arbitrage (i.e. perfect collusion) and Cournot-Nash oligopoly.

Our work differs from JD-F in that we allow only for one link per pair of nodes, but we are still able to discuss route choice for the three node case network. Additionally, in contrast with JD, we study the case of more than two nodes relying on numerical simulations. A network increasing in complexity is considered aiming at disentangling the effects of alternative assumptions on both the type of competition in the product market and the shape of the transport network. Finally, our approach for addressing economy-wide welfare differs from both JD-F and JD, as we look at the entire magnitude of social welfare and not only at the surplus from trade.

The network equilibrium models employed in this paper correspond to a partial equilibrium concept and are especially suited for situations where price and output changes in the transportation sector do not significantly affect capital and labor markets. Income effects, intermediate goods and inventory issues are also ruled out.<sup>3</sup> Moreover, the focus here is on steady-state network equilibrium models featuring interregional one-commodity trade, as opposed to network models emphasizing passenger flows (Beckman et al 1956) or those investigating freight transportation in a dynamic context (Friesz et al. 2001).<sup>4</sup> Additionally, we allow for more than two nodes and the existence of transshipment nodes, in the simulation exercise, in order to be able to discuss the interaction of congestion effects, Wardrop equilibria and the possible presence of Braess's paradox type of phenomena.

The rest of the paper consists of three main sections. Firstly, in the next section a review of what has been discussed in the literature up to now is presented and put it in the perspective of our approach. The discussion in this section is conducted mainly through graphical analysis. Additionally to the usual spatial perfect competition case,

---

<sup>1</sup> See also Galvez and Jara-Díaz (1975). This related literature is summarized in Friesz (1985).

<sup>2</sup> The conditions characterizing equilibrium for the monopolistic production case in JD are quite different from those used here, but also from the literature on SPE under imperfect competition (see Harker, 1986). As will be discussed later in the paper, Jara-Díaz (1986) assumes a spatial monopoly with arbitrage, as defined in Takayama and Judge (1971).

<sup>3</sup> Waquil and Cox (1995) consider intermediate production within SPE models.

<sup>4</sup> The generalization to multi-commodity economies is made possible through a multi-copy network formulation which in the case of non-separable functions implies no loss of generality when using a single-commodity formulation (Friesz et al. 1998).

both the spatial monopoly without resale and Cournot-Nash oligopoly cases are discussed in detail. In section three we use numerical simulations to evaluate the surplus equivalence in a three region economy embedded in two different transport networks. Finally, the last section concludes and discusses future work.

## 2. Surplus change equivalence in a two-region economy

In this section a graphical exposition is employed to review what has been already pointed out in JD-F with respect to benefits measures comparison using a SPE model under perfect competition. More important, based on this review we extend their analysis to the cases of perfect collusion without resale across regions and to Cournot-Nash oligopoly. A two-region economy is assumed and transport costs are taken initially as a constant (i.e. independent of the flows).<sup>5</sup> Before going to the main issue in this section, more detail on the *surplus change equivalence problem* will be given. In particular, we discuss how users' benefits in the transport market itself are usually measured, both for the case with and without congestion effects.<sup>6</sup> Additionally, we discuss the composition of total welfare in a SPE model.

### *Surplus change equivalence*

The main concern in this paper is the comparison between users' benefits arising in the transport market itself as a change in transport consumers' surplus (TCS), with those benefits arising at an aggregate level as changes in total social welfare. This research question can be said to start formally with Tinbergen (1957). After this work, as far as we know, no further contributions were seemed to be cast in a similar or related manner until Kanemoto and Mera (1982), which explicitly recognized his work in the context of a first-best general equilibrium economy subject to non-marginal transport cost reductions. JD-F and JD adopted a related approach and the latter called the comparison the *surplus equivalence problem*. As analyzed in JD, the comparison is between the "trade" surplus at an economy-wide scale and the TCS, from an equilibrium without trade to one with positive trade.<sup>7</sup> This is in contrast with the previous and more recent literature on this issue where the comparison is usually reported as the ratio of the economy-wide welfare change over the transport market measure when both the initial and final equilibriums are characterized by positive trade flows. Under the assumptions taken in JD-F (i.e. perfect competition in production) there is no difference between both approaches but when the consequences of intermediate competition arrangements are to be analyzed the correct comparison corresponds to the last interpretation. In this respect, our work departs from JD but employs the second interpretation; consequently we refer to the *surplus change equivalence*, instead of the (trade) surplus equivalence, and compute the economy-wide welfare considering both the traded and non-traded

---

<sup>5</sup> At the end of the section the extension to transport cost depending on the flows is discussed briefly.

<sup>6</sup> This discussion is referred later in the paper when the numerical simulations are presented.

<sup>7</sup> As discussed in Jara-Díaz and Freisz (1982) the equivalence holds as well for a comparison between two equilibriums with positive trade. In this case the change in surpluses also holds, but in their paper the economy-wide surplus still refers only to the trade surplus.

quantities. The common practice for this second approach is to report results as a ratio of economy-wide benefits to the change in TCS. The benchmark for this ratio is a level of one when distortions exist neither in the transport market nor in the rest of the economy.

The main components of the surplus change equivalence are two users' benefit measures. One is for the entire economy and can take as many possibilities as there are available according to welfare economics, but in general will be restricted by the background economic equilibrium trade model employed. For instance, in Meléndez-Hidalgo et. al (2003) both the equivalent and compensated variations are used to compute total welfare changes and in Kanemoto and Mera (1982) more sophisticated total welfare measures are proposed. In both of these papers a general equilibrium approach is employed to model trade across space complicating the issue of measuring total welfare. In a partial equilibrium framework, as is the case in this paper, total welfare or *the social welfare (SW) function* is simply composed of net surplus to consumers plus producers' profits (including transportation costs). Only if there are available instruments for the government to influence the allocation of resources, the government surplus would be added to this two.<sup>8</sup>

The second component of the surplus change equivalence problem is a measure of direct benefits based on a derived demand for these services and captured in the change in TCS. As for the previous welfare measure, the TCS change can be computed based in as many ways available within welfare economics with respect to consumers' benefits. These options are again restricted by the chosen economic model. For the case of SPE models, due to the unknown functional form of the transport services demand and the absence of income effects, there are only two possible ways of measuring the TCS. One may compute it as the integral over an implicit expression for the derived demand or as an approximation using the *rule of a half*.<sup>9</sup>

In Figures 1 and 2 we show as shaded areas the users' benefits arising in the transport market as a result of a decrease in the equilibrium transport cost. These benefits are measured on a (inverse) derived transport demand,  $D_i(\cdot)$ , which in the case of a two-region SPE model corresponds, as it will be shown later, to the amount of production (consumption) in the exporting (importing) region that is traded due to a positive gap in the willingness to pay between the importing and exporting regions -at a given transport cost level.

---

<sup>8</sup> In Cremer et al (2003), a related paper, the social planner welfare function or SW is decomposed into the sum of consumers' (net) surplus, the transport network operator income (or merchandizing surplus) and the producer surplus (excluding transport costs). This is equivalent to the approach followed here but since we are not considering social planner decisions we prefer to exclude the distinction they made.

<sup>9</sup> If it is the case that the "derived transport demand" curve moves from an initial equilibrium to the final one, after an infrastructure improvement, then the consumer's surplus might be path dependent if certain conditions do not hold (Jara-Díaz and Friesz (1982)). In this case we employ a linear path from the initial to the final equilibrium, which is the same as assuming that the final effect is the sum of marginal consecutive effects from changes in the direction assumed.

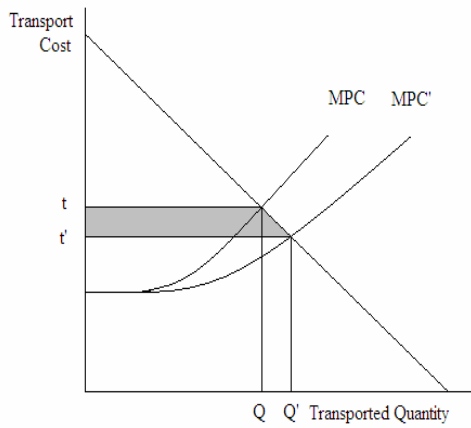

Figure 1: Users' Benefits in the Transport Market without congestion charging.

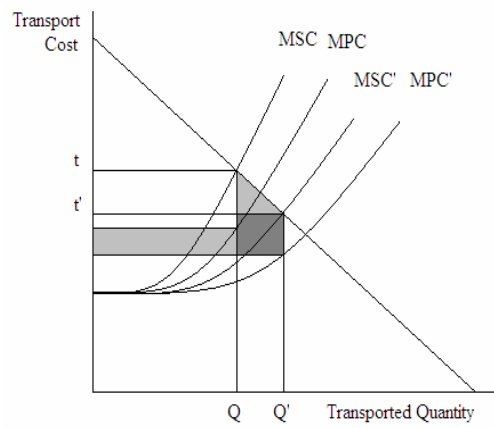

Figure 2: Users' Benefits in the Transport Market with congestion charging.

A reduction in the transport cost from  $t$  to  $t'$  is shown in both Figures. The traditional Marshallian consumers' surplus variation gives the users' benefits as the change in TCS:

$$\Delta TCS = - \int_{t'}^t Dt(s) ds$$

These benefits result both from cost savings in transporting the previous level of trade but also from increased trade induced by the decrease in the transport cost. This latter component has been interpreted previously in the literature as the average of the maximum and minimum possible benefits for the induced trade when the rule of a half is applied to approximate the users' benefits (Neuberger (1971)).<sup>10</sup>

The case of no congestion charging is shown in Fig.1. As discussed in Mohring (1976), among others, the benefits are measured with respect to the marginal private costs (MPC) of transportation when this is a function of the flow.<sup>11</sup> In this case the transport benefits measured as a change in TCS will include a transport market welfare loss associated with the congestion externality.<sup>12</sup> In Fig.2 the case of congestion charging is shown. To the traditional rule of a half components (the triangle and the horizontal rectangle in light-colour) has to be added the vertical rectangle representing the net increase in congestion charging revenue resulting from the exogenous decrease in transport costs.

<sup>10</sup> A first difference arises here with respect to JD-F as they consider modal choice leading to a linear (Hoteling type) integral of the demand function. To go around the path dependency problem under linear integration they assume that Green's condition holds.

<sup>11</sup> The MPC is equivalent to the average cost of transportation, used in other contexts.

<sup>12</sup> This is not shown in the Figure but it would be clear if, as in Fig.2, both the marginal private and social costs are drawn. In that case the equilibrium at the intersection of the marginal private costs with the derived demand will correspond (at the equilibrium level of flow) with a level of marginal social cost above the private level. The area under the marginal social cost and above the transport demand from the point of intersection of this curve with the transport demand, to the equilibrium defined as in Fig. 1, will correspond to the deadweight loss due to the congestion externality.

In the rest of this section we will discuss the equivalence between users' benefits measures under three different assumptions for the industrial organization in production. The first case analyzed is the one originally addressed in JD-F for perfect competition without congestion effects. It would be argued later in the paper that the case with congestion is equivalent to the one without congestion with the only qualification that the users' benefits in the transport market must be computed as shown in Fig.2. The second case analyzed is the perfect collusion assumption which has not been discussed before in the literature. JD considers monopolistic competition in production but employs different conditions to characterize the equilibrium (i.e. resale is possible). Again the case without congestion is the one discussed in detail but the same discussion applies to the case with congestion effects applying the same qualification as in the perfect competition case. Finally, we also contribute to the literature on the surplus equivalence problem by analysing the Cournot-Nash competition case. To simplify the exposition this latter case is presented for a situation where only one of the firms is exporting to the other region meaning that both firms compete in the importing market but the exporting firm behaves as a monopolist in its own market. In what follows the exposition will be mainly based on graphs. In section three we formalize the models before discussing numerical simulations for a three regions economy embedded in two different networks.

*Perfect competition*

Our final aim is to compare changes in SW with the change in TCS -measured as the area to the left of the derived transportation demand- both arising after an initial equilibrium with trade is disturbed by an improvement in the capacity of a transport link between a pair of regions. In Fig. 3 and 4 this exercise is presented as in JD-F for a two-node-one-link network and the resulting (inverse) derived transport demand,  $D_i(\cdot)$ , is shown in Fig.5. In contrast with their paper we assume the homogeneous good is transported from region 1 to region 2, with direct and inverse demand and supply functions per region respectively given by:

$$\begin{aligned} D_i &= D(p_i); & p_i &= \theta(D_i) \\ S_i &= S(p_i); & p_i &= \psi(S_i) \end{aligned}$$

with  $i=\{1,2\}$  and excess demand and supply functions given by:

$$\begin{aligned} ED_2(p_2) &= D_2(p_2) - S_2(p_2) \\ ES_1(p_1) &= D_1(p_1) - S_1(p_1) \end{aligned}$$

In Fig.3 the equilibrium prices arising with positive trade,  $p_1$  and  $p_2$ , are shown. A different pair of prices is associated with both an initial and final level of the transport cost,  $t$  and  $t'$ , respectively. In Fig. 4 the corresponding equilibrium excess supply and excess demand quantities are derived based on the difference in quantity demanded and supplied in a particular region for each transport cost level.

In contrast to JD-F when computing the economy-wide surpluses in each region we use a quantity formulation of the SPE instead of a price formulation<sup>13</sup>. This is reflected in the figures when measuring the economy-wide welfare (shaded areas), as we consider not only the net surplus from *trade* (the triangles shown in JD-F and JD) but the entire surplus in consumption and production for both regions. As discussed before, this distinction is central when considering competition arrangements others than perfect competition in production, as we do when analyzing Cournot-Nash competition and Perfect Collusion.

Figure 3 shows that the result given in JD-F concerning the trade surplus equivalence when perfect competition is assumed in both the transport-using and transport sectors, has a parallel in the quantity formulation.<sup>14</sup> From a quantity formulation perspective we can re-state their finding as follows: the change in total social welfare from a situation with trade across regions, as compared to one without trade, will correspond to the entire TCS arising for the final transported quantity,  $T$ . The change in social welfare is precisely the net trade surplus that JD-F emphasize. Their focus is on the benefits of trade and consequently they use the excess supply and demand to characterize these benefits and to link them with the derived transport demand<sup>15</sup>. In contrast, in Fig.3 and Fig 4 our emphasis is different. In those figures it is shown that in a quantity formulation the equivalence that holds is that of the users' benefits (change in TCS) with the change in SW when comparing two decentralized equilibriums. This approach is more general as those equilibriums can include one without trade as in JD and JD-F (and as discussed above), but also the more general case we are interested in where we compare two equilibriums with positive trade (i.e. positive and not prohibited trade costs). The *change* in TCS is also captured by the excess supply and demand curves net surpluses as shown in Fig. 4, but again, this result applies only to perfect competition conditions meaning that is of no use in our more general approach.

In Fig. 3 we show two decentralized equilibriums arising from two different levels of the transport costs. In both equilibriums region 1 is exporting the homogeneous good to region 2. In the original equilibrium, region 1 produces  $S_1$  and consumes  $D_1$  (less than  $S_1$ ) at a price  $p_1$  while region 2 produces at  $S_2$  and consumes  $D_2$  units of the good ( $> S_2$ ) at a price  $p_2$ . At those prices there would be an interest in trade from region 1 to region 2 and assuming that the transport cost is initially a constant this trade will be conducted until the point where the difference in prices ( $p_1 - p_2$ ) equals the transport cost level,  $t$ .<sup>16</sup> The total social welfare for this (initial) equilibrium will correspond to the sum of both light-shaded regions in Fig. 3, which is the sum of consumers' (net) surplus in both

<sup>13</sup> The domain for integration when computing the SW refers to quantities in the quantity formulation and to prices, as in JD-F, for the price formulation.

<sup>14</sup> This is not a surprising result in the light of the isomorphism of both formulations already discussed in Takayama and Woodland (1970).

<sup>15</sup> JD-F also argues that the change in TCS when comparing two equilibria with positive transport cost is also equivalent to the change in SW. This is basically the same approach to look at the equivalency in surpluses as the one taken in our paper.

<sup>16</sup> The transport cost level represents the willingness-to-pay to move the units from region 1 to region 2 and under perfect equilibrium is equal to the difference in prices between the importing and exporting region. Jara-Díaz (1986) shows that this latter condition together with the conservation flow condition stating the equality between excess demand and excess supply, can be used to construct an inverse derived transportation demand in terms of the inverse excess demand and supply functions. Based on this latter result, the TCS can be shown to be equal to the change in SW from autarky to the equilibrium with trade. See Jara-Díaz (1986), pag. 383.

regions and the firms' profits including transport costs.<sup>17</sup> After this equilibrium is disturbed by a decrease in the cost of transportation from  $t$  to  $t'$ , the new equilibrium will correspond to more trade from region 1 to 2 and new prices at  $p_1'$  and  $p_2'$ . The gains arising from the infrastructure improvement will be shared by producers of the exporting region and consumers of the importing one according to the elasticities of demand and supply in both regions.<sup>18</sup> Total welfare in the new equilibrium will include not only the light-shaded areas but also the dark-shaded ones, which correspond to the increase in welfare due to increased trade. The change in social welfare is composed of *saved costs* of transporting the previous traded quantity –transferred in part both to producers and consumers– and extra benefits arising from induced trade after the reduced transport cost opens a gap between initial equilibrium prices across regions that is subsequently reduced to zero with more trade.

At this point it should be easier to see the parallel with JD-F. Since in their analysis distortions in the economy are ruled-out, their focus is on the benefits from trade at an economy-wide level. Ignoring the surplus arising in autarky is innocuous under their assumptions. As a consequence the sum of surpluses arising on an excess supply and excess demand will completely capture this extra surplus as shown in Fig.4. While assuming perfect competition there is no serious implication from this approach since there are no distortions in production and the whole extra benefit arising from a reduction in transport costs comes entirely from the new trade flows. If we want to look at other types of industrial organization in production the price formulation is no longer illustrative of what is happening at the level of total welfare, then our emphasis on the entire surplus (e.g. total social welfare).<sup>19</sup>

The surplus (change) equivalence under perfect competition is illustrated in Fig. 3 and Fig. 5. As a result of a decrease in transport costs from  $t$  ( $= p_1 - p_2$ ) to  $t'$  ( $= p_1' - p_2'$ ), the change in total welfare as shown in Fig.3 is completely captured by the users' benefits measured in the transport market itself, as a change in the transport consumers' surplus (TCS). This is shown in Fig. 5 where the derived transport demand,  $D_t$ , arising from this simple model is depicted. The TCS change corresponds to the dark-shaded area in Fig.5 which exactly matches the sum of dark-shaded areas in Fig.3 (and Fig.4).<sup>20</sup> The new transport cost will match the difference in prices at the new equilibrium and is associated with a level of trade given by  $T'$  ( $= D_1' - S_1' = S_2' - D_2'$ ), which is greater than the level of trade associated with the previous equilibrium,  $T$  ( $= D_1 - S_1 = S_2 - D_2$ ). The sharing of benefits across regions depends on their elasticities of the excess demand and supply, as discussed before.

<sup>17</sup> Besides we are in a competitive economy, there are non-zero profits (e.g. normal profits) for the non-marginal firms. These are measured as the difference between the total sales minus the integral of the supply curve up to the equilibrium quantity.

<sup>18</sup> See Jenkins and Kuo (2006) for more on the sharing of benefits and for an application of this framework to the actual evaluation of infrastructure improvements across countries.

<sup>19</sup> The price formulation is still indicative of what is happening with the benefits of trading even in the case of imperfect competition, but drawing a parallel to the discussion in perfect competition we can carry out all the analysis based on the quantity formulation.

<sup>20</sup> This is the main result in relation to the surplus equivalence issue shown in Jara-Díaz and Friesz (1982) and Jara-Díaz (1986) for the SPE model in price formulation.



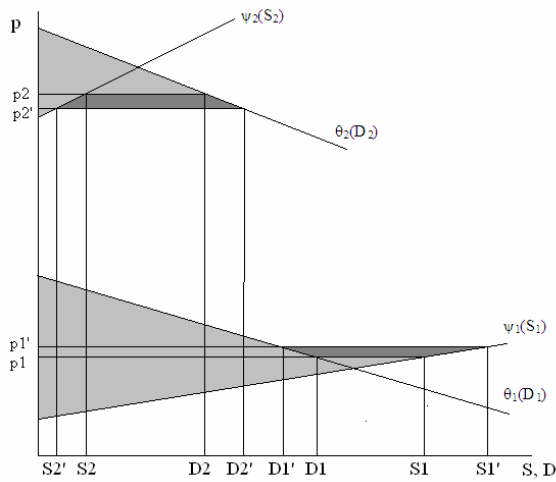

Figure 3.

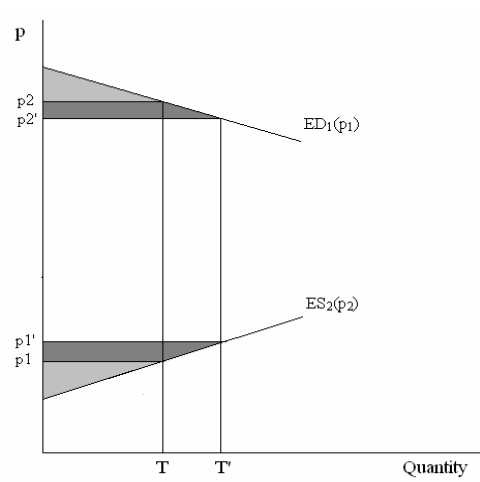

Figure 4.

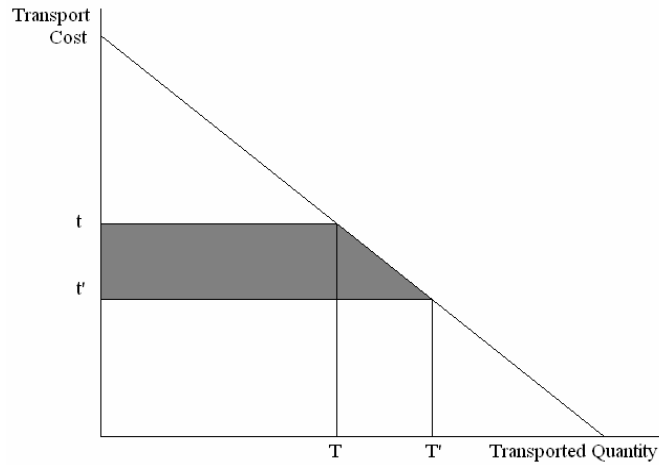

Figure 5.

*Perfect collusion (spatial monopoly without resale)*

The competitive SPE model makes a strong assumption concerning the market structure. It supposes that markets are perfectly competitive within a region; that is, price will always equal marginal cost in every region since there are infinite number of both consumers and producers per region. Analyzing spatial markets with a perfect competition assumption has been criticized in the literature (Scotchmer and Thisse, 1992; Sheppard and Curry, 1982). The existence of spatial monopolies is well recognized and the very existence of a spatial structure put to question the use of the perfect competition assumption if one recognizes that a firm closer to a market will have an advantage over a firm farther away when transportation is not costless (Harker, 1986). In this sub-section we relax the assumption of perfect competition in production, initially considering a spatial monopoly in production or as we prefer to interpret it here, perfect collusion among regional producers. This competition arrangement is different to the monopolistic competition considered in JD, as he allows for resale among regions

meaning that prices between a pair of regions cannot differ more than the magnitude of the transport cost between them.<sup>21</sup>

A first attempt to consider imperfect competition within SPE was taken by Takayama and Judge (1971). In their setting production is undertaken by a monopolist operating in all regions. If resale among regions is not possible, the monopolist discriminates prices across regions. They showed that when there is trade from a region  $i$  to another region  $j$ , the marginal revenue of the firm in market  $j$  equals the marginal costs of the firm in region  $i$  plus the transportation cost from  $i$  to  $j$ . In the monopoly case prices are higher and production levels lower as compared to the competitive case. Takayama and Judge (1971) also explored monopoly pricing when resale among regions is possible, that is, arbitrage is allowed across regions. This impose additional constraints for the monopoly, namely prices among regions can not differ more than the transportation cost between them. The latter approach is the one followed in JD when he refers to monopolistic competition. The former interpretation, allowing for price discrimination, is the one we use in this paper.

It was shown in the previous sub-section that under perfect competition the change in SW corresponds exactly with the change in TCS, when a reduction in transport costs is in place. For the perfect collusion case this result does not hold anymore. The main difference concerns the measuring of TCS changes. For the perfect competition case and at a given transport cost level, the demand together with the supply curves (sum of marginal costs across active firms in a region) define in every region an equilibrium price level such that the traded quantity is a positive gap between the amount demanded and supplied at the importing region particular price, which in turn matches a positive gap between the supplied and demanded quantity in the exporting region at a lower price. This latter price differs from the price of the importing region by the level of the transport cost. J-D shows (pgs 380-82) that for a two region economy a derived transportation demand can be constructed from the equilibrium relation between prices across regions and the excess demand and supply. It follows from this that the willingness to pay for the movement of the traded units (e.g. derived transport demand) is in fact constructed based on the final demand and supply functions.

The equilibrium condition in the perfect collusion case corresponds to an equalization of marginal costs and marginal revenues in each region and not in prices as the perfect competition case. This equalization define the equilibrium demanded and supplied quantities which in turn fulfil a conservation of flow condition implying an equalization of “desired” trade flows across regions.<sup>22</sup> Consequently it is the marginal revenue instead of the final demand which defines, together with the marginal cost functions, the willingness to pay for trading goods in the perfect collusion case. The equilibrium condition across regions in the perfect collusion case says that the exporting region marginal cost plus the transportation cost must be equal to the importing region marginal revenue. Then the benefits from trade are captured in a derived transportation demand constructed from these curves. This is in parallel to the procedure employed in J-D for the perfect competition case but with the marginal revenue curve replacing the total demand and the total supply being replaced by the marginal cost function in each

---

<sup>21</sup> See Takayama and Judge, (1971).

<sup>22</sup> More formally, a conservation flow condition is behind the equalization of “desired” and “realized” trade flows.

region.<sup>23</sup> Since the SW is measured in the same way irrespective of the competition arrangement in production, it follows that the users' benefits will in general differ from the change in SW, after an infrastructure improvement.

In Figures 6 and 7 the equilibrium before and after the transport cost reduction is shown for the perfect collusion case. In Fig. 6 the equilibrium is, as before, one where region 2 imports from region 1 before and after the improvement in infrastructure. The SW will correspond to the sum of all grey areas. In contrast to the case of perfect competition, the transported quantity is defined as a gap between the marginal cost and marginal revenue curves at the equilibrium across regions. This equilibrium results from the equalization of marginal revenue and costs in each region and the equalization of the marginal revenue for the importing region with the sum of the marginal and transport cost from the exporting region. The traded quantity is not anymore defined based on the market demand as in perfect competition. The benefits from trade (e.g. trade surplus) are shown as in JD as the triangular grey areas forming from the crossing of the marginal revenue and marginal cost curves. The two-firm "cartel" decides on how to allocate production as to maximize total profits and in equilibrium discriminate prices across regions.

Figure 7 shows the consequences of a reduction in the transport cost level. After the reduction had defined a new equilibrium, characterized by a lower price in region 2 but a higher one in region 1 (not shown in the price scale to keep the figure clear enough), the change in SW is no longer the sum of the horizontal dark-grey areas as in the previous case (Fig.3). In addition to the trade surplus (horizontal dark areas) there is a net effect related to mark-up trade-off across regions which is exercised by the "cartel" in order to maximize total profits. Two vertical dark-grey areas reflect this trade-off. In the exporting region (region 1) there is a loss in profits because fewer units are consumed locally and instead are now exported. There is also a net loss in consumer surplus given by the reduction in demand ( $= D_1' - D_1$ ) and reflected by the upper triangle in the horizontal dark-shaded bar in the lower set of curves in Fig.7. Additionally, with the increase in trade and demand in region 2 ( $= D_2' - D_2$ ) there is a net increase in consumer surplus and also an increase in profits dictated by the mark-up exercised (e.g. profits) by the cartel in the new units imported from region 1. This is reflected by the horizontal bar in the upper set of curves in that figure. The net effect defines the extra component in the change in SW, as compared to the perfect competition case. The difference in users' benefits measured in the transport market itself and those reflected as aggregate welfare changes will correspond in this case precisely to the net sum of the integrals between the total demand and marginal revenue curves, from the original quantity demanded ( $D_1$  and  $D_2$ ) to the new quantities ( $D_1'$  and  $D_2'$ ) in both the importing and exporting market. Being that in general one of these areas is negative (for the exporter) and one is positive (for the importer), the change in SW will differ from the change in TCS. The change in profits is expected to be always positive since the monopolist maximizes across all regions. Besides that, the net effect can still be negative if the net changes in consumers' surplus across regions end up being negative.

---

<sup>23</sup> The focus changes here from a market view to a firm view of benefits and costs since we are assuming that there is a "cartel" of regional firms behaving as a monopolist over the entire set of regions in the economy. The willingness to pay for transporting the good in this case refers to in a direct way to the firm, and indirectly to the final consumer.

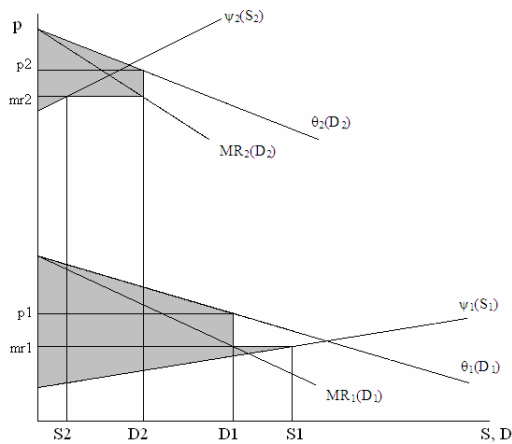

Figure 6.

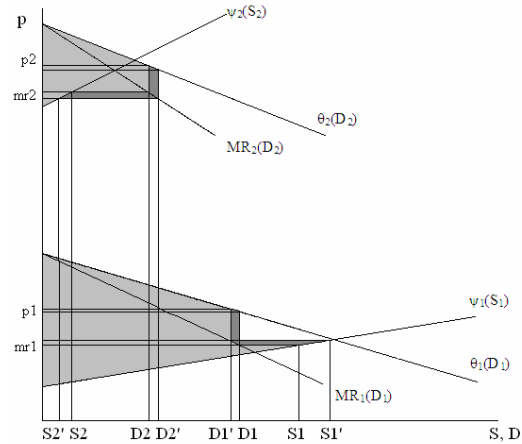

Figure 7.

The magnitude of the difference will depend on the elasticity of demand in each market. The possibility for the “cartel” of exercising market power and discriminating in prices across regions creates a gap between the benefits at an aggregate level and those arising in the transport market itself. After a reduction in the transport cost the cartel trade-offs profits margins across regions in order to maximize profits, meaning that the change in total profits will always be positive. In contrast, the net change in consumer’s surplus included in the horizontal bar can be positive or negative and could even compensate the net change in profits.

### Cournot-Nash competition

Hashimoto (1984) has extended the perfect competition SPE model to a spatial Nash non-cooperative equilibrium model. He considers one firm per-region competing *à la* Cournot-Nash with firms from other regions. A comparison of the Nash equilibrium model with the perfect competition and monopoly cases shows that the differentials in interregional prices in the Nash equilibrium are greater than in the perfect equilibrium case and lower than in the monopoly case. Harker (1986) and Nagurney (1993) also present a spatial oligopoly model where the profit function of each firm considers the transportation costs from the production plants to the demand markets. We follow closely the formulation by Harker (1986).

In order to simplify the discussion of the Cournot-Nash competition case, we make the extreme assumption that there is only one firm controlling production in each region-market. In a more general case we could take the situation where more than one firm operates in a particular region. As pointed out by Harker (1986), our assumption is not restrictive in the sense that any particular region, in which two or more firms operate, can always be decomposed into sub regions in which only one firm operates. Then we consider two firms, firm 1 and 2, supplying both its internal market and the other’s region market. Each firm distribute its production between the two markets in a way that maximizes its total profits and takes transport costs as part of the total costs of supplying the markets.<sup>24</sup> In particular, firm 1 and 2 supply the “internal” market up to a point where the marginal costs of production equals the marginal revenue based on the

<sup>24</sup> This is similar to the segmented market assumption in Brander and Krugman (1983).

*residual* perceived demand in that market. This residual demand results from subtracting the amount supplied by other firms from the total demand, in this case, the amount supplied by firm 2 and firm 1, respectively. Both firms supply consumers in the “competing” region, and they do that until a point where the marginal revenue of supplying that region, based on the residual demand in that market, equal the sum of the marginal cost of its production (in the region of origin) plus the transport cost incurred in the last unit shipped. The residual demand in this case corresponds to the subtraction from the total demand in the “foreign” market of the amount supplied by other firms, in our framework the amount supplied by the local producer. An important difference arises at this point in comparison with previous industrial organizations in production because both firms might be supplying both markets and consequently we could be in a situation of *two-way trade*.<sup>25</sup> The implications from this to the surplus equivalence are significant since even though an infrastructure improvement might only affect a one-way link, the final equilibrium will be reflected also in the trade going on an opposite direction (as in the two-link model of JD-F).

The initial equilibrium in this environment can be seen more clearly in Figures 8 to 10. To further simplify the analysis we are making the extra assumption that in equilibrium there is only trade from region 1 to region 2, that is, region 1 producer exercise full market power over its own region demand and additionally competes in region 2 market with the local producer. Fig.8 is basically equivalent to the bottom part of Fig.6 where region 1 producer is the exporter and also behaves monopolistically over its own region total demand. The benefits from trade in that region correspond to the dark-grey area, that is, the total benefits arising from the amount of goods sent to region 2,  $T_{12} (= S_1 - D_1)$ . In Fig.9 and Fig. 10 the equilibrium is shown for regional market 2. In this market the situation is different since there is strategic interaction among firms. The total market demand,  $D_2(P_2)$ , is assumed to take a linear form given by  $\theta_2(D_2) = \rho_2 - \eta_2 D_2$ ; then the perceived inverse residual demand for the local firm,  $\theta_{22}(D_2)$ , results from subtracting horizontally  $D_{21}$ , the demand in region 2 served by region 1 firm. In terms of the inverse demand this is equivalent to subtract a constant,  $\eta_2 D_{21}$ , from  $\theta_2(D_2)$ , which is graphically shown as vertically subtracting this magnitude from the total inverse demand. The perceived inverse residual demand is then given by:

$$\theta_{22}(D_{22}) = \rho_2 - \eta_2 (D_{22} + D_{21}) = (\rho_2 - \eta_2 D_{22}) - \eta_2 D_{21}$$

with  $(D_{21}=T_{12})$  in equilibrium. The associated residual marginal revenue faced by firm 2 is also shown in Fig.9, and the equilibrium production corresponds to a point where both marginal revenue and marginal costs for this firm coincide ( $S_2 = D_{22}$ ). The equilibrium for firm 1 in region 2 is shown in Fig.10. There, the residual demand faced by firm 1 is constructed as the result from vertically subtracting a quantity  $\eta_2 D_{22}$  from the inverse demand, which is related to the part of total demand in that market which is served by the local firm. The equalization of the associated residual marginal revenue with the sum of the equilibrium marginal revenue in region 1 plus the transport cost incurred in the last unit sent from region 1 to 2, define the amount of firm 1's total production directed to region 2 ( $D_{21}=T_{12}$ ). More concretely, firm 1 allocate its total production between the local and foreign markets based on an equalization of marginal costs to marginal revenue which in the case of the foreign market, and due to the

<sup>25</sup> Cross-hauling is due to strategic interactions across firms, as discussed in Brander (1981).

assumption of full market power in the local market, corresponds to the sum of the marginal cost in the region of origin plus the transport cost per unit of good sent. This last sum is shown in Fig.9 and Fig.10 as a horizontal line. This line also helps to show how the SW level associated with this equilibrium is computed.

The final demand in region 2,  $D_2$ , will be composed of the sum of the quantity served by each firm ( $D_2=D_{22} + D_{12}$ ), and this sum plugged into the total demand defines an equilibrium price,  $p_2$ . Consequently, SW being the sum of welfare in each region will correspond to all shaded areas in Figures 8 and 9. The area in Fig.8 is exactly the same as the one discussed for the exporting region in the perfect collusion case, as we are assuming that region 2 does not export to region 1. The area in Fig. 9 is quite different from the perfect collusion case. It includes the net consumers' surplus plus the net local producer surplus, including a mark-up over the average cost of production incurred in all units sold,  $(p_2-mc_2)$ , plus a smaller mark-up area defined over all the units sent from region 1 and sold in region 2,  $(p_2-mr_2-t_{12})$ . The total amount demanded in equilibrium in region 2 is in general bigger than the one obtained under perfect collusion.

An important difference also arises when computing the users' benefits based on the derived transport demand. In principle, one might then to think that we should be able to apply a similar approach as the one employed to derive the users' benefits in the perfect collusion case, that is, instead of using the final demand as in the perfect competition case we can refer to the marginal revenue curve to define a derived transportation demand. In the particular case that we are dealing with here, we would expect that the reference will be to the residual marginal revenue distinguish between the sales in the "local" and "foreign" markets. In fact, this approach is no longer valid here due to the strategic interaction that characterizes firm's behaviour. In Fig.10, the benefits from trade are valued as the area below the residual marginal revenue curve faced by firm 1 in region 2 and above the sum of the marginal revenue in the region of origin plus the transport cost per unit sent. This is the derived transportation demand in this case, defining the willingness to move goods from one region to the other. The total benefits from transporting  $T_{12}$  units of the good correspond to the triangular dark-shaded area in that figure. In Fig. 8, the benefits from trade are shown, as in the perfect collusion case, as the triangular dark-shaded area. For the particular equilibrium shown there the TCS, for a given transport cost level, will be the sum of these two areas.

The main complication with the computation of users' benefits (i.e.  $\Delta TCS$ ) under these circumstances is that due to the Cournot's expectations at play in the oligopoly case, the residual marginal demand and revenue curves do not have a fixed position from equilibrium to equilibrium. More specifically, when an original equilibrium is disturbed by an improvement in the infrastructure, the distribution of production across markets will vary and consequently also the location of the residual demands and marginal revenues. This complicates the analysis as we know it until now since we will have to incorporate these re-locations in residuals demands when computing the benefits in the transport market itself and subsequently when trying to compare them with the total social welfare change. Following Mohring (1956), among others, a linear path of integration is employed.

In Fig. 13 it is shown what is at stake when an initial equilibrium is disturbed by a decrease in the transport costs. The reduction in this cost increases the profitability for region 1 of allocating an extra unit of its production to region 2, as compared to its local market. This increase firm 1 exports and in turn weakens the position of region 2 local firm; a contraction in the residual demand for firm 2 results from this. This contraction

in firm 2 residual demand generate a compensating expansion in region 1 residual demand which in turn is reflected in region 1 as an extra increase in production that leads to a higher marginal costs, compensating the increase in the residual marginal revenue in region 2. The process continues until a new equilibrium is achieved. The reduction in transport cost generates a re-composition in market share in region 2 that favours the exporting region firm.

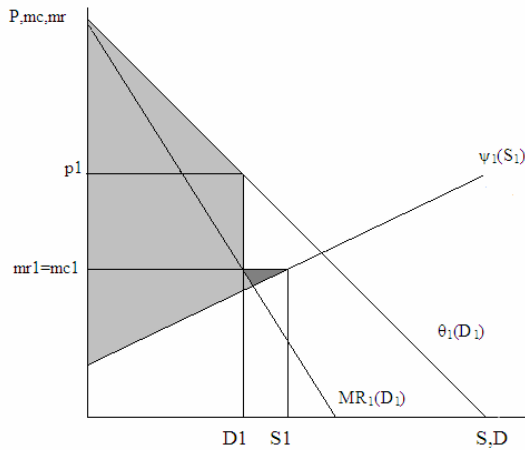

Figure 8.

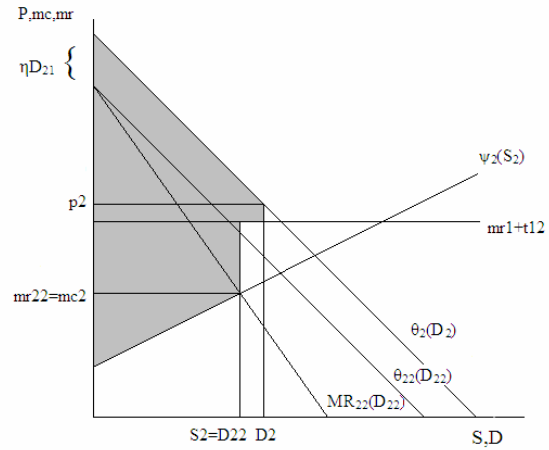

Figure 9.

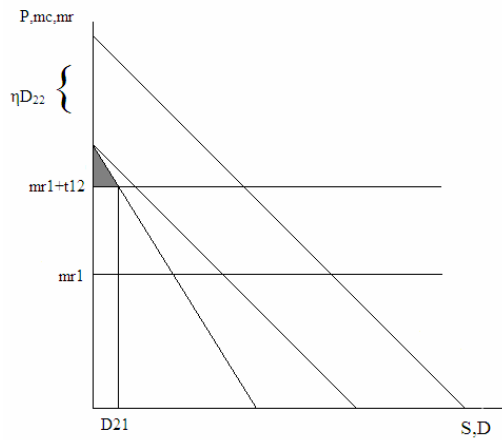

Figure 10.

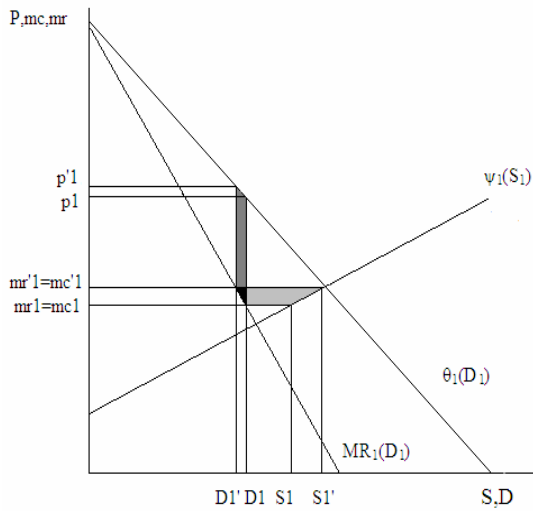

Figure 11.

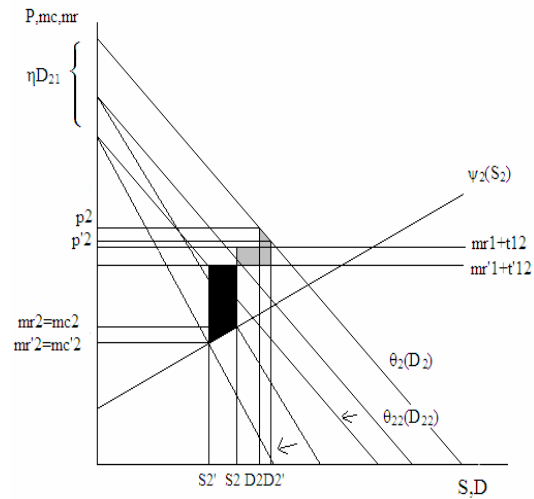

Figure 12.

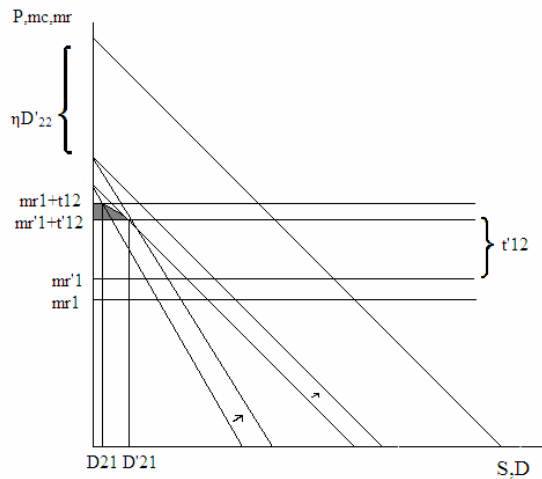

Figure 13.

The users' benefits arising from the transport infrastructure improvement will correspond to the sum of extra benefits from trade in region 1 and region 2. As before, the net benefits from trade in region 1 correspond to the horizontal (light) grey area in Fig. 11. A distinct case occurs in region 2 since the curve used to value the benefits from trade moves from the initial to the final equilibrium. To compute the benefits in this case we use a linear path of integration from the original to the final equilibrium assuming that the total benefits correspond to the sum of consecutive marginal movements in the direction of the final equilibrium. The corresponding benefits are the light-grey area in Fig.13.

Now we are ready to compare the users' benefits with the change in SW under Cournot-Nash competition. In general the change in SW will correspond to the change in the shaded areas in Fig. 8 and 9. In Fig. 11 and Fig. 12 we show, respectively, the change in SW of regions 1 and 2 after the infrastructure improvement defines a new equilibrium. As before, the case of region 1 is parallel to the case of perfect collusion, being the change in welfare the sum of a positive term defining the benefits from extra trade and a negative area defining the losses from consumers and producers of a



reallocation of production from the local to the foreign region. There is again a small area in which the benefits and dis-benefits associated with the new equilibrium are cancelling out. For region 2, where there is competition between firms in supplying the market, the situation is significantly different. Increased competition faced by firm 2 results in a market share loss,  $S_2-S_2'$ , for this firm. Consequently its profits are reduced in the mark-up that was before applied to these units, and this is reflected as a negative vertical area in black. Firm 1, in contrast, increases its mark-up over the previous units and also increases its profits applying the new equilibrium mark-up over the extra units sell in region 2. Part of the extra profits correspond to a transfer from firm 2 and does not appear as welfare increase. The other part appears as a horizontal positive area in light grey. A final positive triangular area in light grey at the top corresponds to the benefits going to the consumers from extra consumption at a lower price that additionally is not translated as extra profits to the producers.

It is clear from the previous discussion that the change in SW under Cournot-Nash competition will in general not coincide with the users' benefits captured in the transport market. Even more, the former could be higher or lower than the latter, with the final magnitude defined among other things by the elasticity of demand in each market, the number of regions-firms and the shape of the transportation network. There is also not possible to derive a clear link between the two measures of benefits as was the case for the perfect competition and perfect collusion case. The presence of strategic interactions among firms complicates the comparison between benefits measures.

In the next section we discuss in detail the general case of  $n$  regions and formalize the equilibrium condition discussed conceptually thus far. Additionally, congestion in transport and alternative network configurations are discussed. This is also in preparation for the numerical exercises that illustrate and complement the previous sections arguments.

### 3. Surplus equivalence in complex networks with congestion effects

In this section we discuss in more detail the main building blocks of SPE models. The focus of this paper is on inter-regional (e.g. between cities) freight flows. There are two main classes of network models which have been used to analyze inter-region freight movements: *spatial price equilibrium* models and *freight network equilibrium models* (Harker, 1986). The first class focuses on the producer-consumer-shippers interactions in the economy without explicitly determining the microeconomics of these activities. The transportation sector is represented by a directed graph with nodes and links. The transportation costs are not derived from a model of carrier behavior, but are stated as fixed values or as functions of the flows on a discrete network. Additionally producers' and consumers' behavior is incorporated by defining supply and demand functions for each region. In the general case -independently of the producer's industrial organization- the shippers are assumed to behave according to the following two equilibrium principles<sup>26</sup>:

---

<sup>26</sup> An important distinction arises in a Cournot-Nash type of competition as compared to perfect competition and perfect collusion. In the former the marginal revenues in the origin and destination both refers to the same firm whereas in the other two types of industrial organization they refer to the region.

- If there is a flow of commodity  $i$  from any pair of regions  $(k,l)$ , then the marginal cost of commodity  $i$  in  $k$  plus the transportation costs from  $k$  to  $l$  will equal the marginal revenue (e.g. equal price under perfect competition) of the commodity in  $l$ .
- If the marginal costs of commodity  $i$  in  $k$  plus the transportation costs from  $k$  to  $l$  is greater than the marginal revenue of commodity  $i$  in  $l$ , then there will be no flow from  $k$  to  $l$ .

The SPE were originally described qualitatively in Enke (1951), and later formalized by Samuelson (1952) and Takayama and Judge (1964, 1970). In our work we use formulations and extensions from Florian and Los (1982), Friesz et al (1983) and Dafermos and Nagurney (1985), among others.

The second major class of predictive intercity freight models is the *freight network equilibrium models*, in which the focus is on the shipper-carrier interaction. The generation of trips from each region is imposed and assumed to be known in this type of models, in contrast with the SPE that solves for the trip (e.g. trade flows) generation via the interaction between supply and demand functions embedded in a network. An attempt to integrate both types of models is presented in Harker and Friesz (1986a, 1986b) as a *generalized spatial price equilibrium*, and can be seen as a possible extension of the model used here. In the rest of the paper, the focus will be on SPE.

*Spatial price equilibrium* is also one of the two most studied steady-state concepts of network equilibrium (Friesz, 1985). The other type is the *user equilibrium* which is mostly employed in urban passenger networks but as pointed out in Florian and Los (1981) and Harker (1985), can also be fully consistent with SPE featuring multi-paths for a given origin-destination (O-D) pair. This last point will be emphasized in the numerical simulations section when considering trans-shipment nodes and average cost pricing in the transportation sector.<sup>27</sup>

### *Network and industry configuration*

In this section we first specify the network topology for a homogeneous one-commodity economy with single paths between each O-D pairs.<sup>28</sup> The discrete shipper network is represented by a finite-directed graph,  $G[L,W]$ , with  $L$  and  $W$  denoting the full set of nodes and arcs, respectively. The indices  $i, j, k$ , and  $l$  refer to nodes of the network. Define  $W = \{w = (ij); i \in L, j \in L\}$ , to be the set of all origin-destination pairs connecting pairs of regional centroids of trade represented by pairs of nodes in  $L$ . All

---

Additionally, it should be notice that the conditions are given in very general terms, for instance, in the case of perfect competition the marginal revenue is equal to the equilibrium price.

<sup>27</sup> As will be discussed later in the paper when more than two paths are possible a region can play the role of trans-shipment even though it has positive production and consumption itself; a users' equilibrium arise in trade flows going through alternative paths for the same origin-destination pair. For further discussion on users' equilibrium see Fernandez and Friesz (1983). Additionally Dafermos and Nagurney (1985) present an alternative view of the incorporation of user equilibrium in spatial price equilibrium models.

<sup>28</sup> The case for path choice will be introduced when discussing transshipment nodes in the simulations section. Harker (1985a) introduces the concept of path variables.

interactions within agents in the same centroid are conducted through the price system so an implicit assumption of zero transport cost for trade within each centroid applies.<sup>29</sup>

For each region  $l \in L$ ,  $S_l$  is the supplied quantity in this region and  $D_l$  is the demanded quantity. The flow between O-D pair  $(ij) \in W$  is denoted by  $T_{(ij)}$ . Conservation of flow in every region implies:

$$S_l - D_l + \sum_{i \in L} \sum_{(il) \in W} T_{(il)} - \sum_{j \in L} \sum_{(lj) \in W} T_{(lj)} = 0 \quad (1)$$

for all  $l \in L$ . The market clearing condition requires that total demand equal total supply, which is obtained summing up over all  $l \in L$  in (1):

$$\sum_{l \in L} D_l - \sum_{l \in L} S_l = 0 \quad (2)$$

For each O-D pair, a function  $c_{(ij)}(T_{(ij)}, K_{(ij)})$  is defined as the average (marginal private) cost incurred in transporting an unit of good between  $i$  and  $j$ . This is the cost that has to be paid when shipping between O-D pair  $(ij) \in W$ , and depends negatively in infrastructure capacity in the relevant link,  $K_{(ij)}$ , and positively in the transport flow,  $T_{(ij)}$ , in that link.<sup>30</sup> Furthermore  $c_{(ij)}(\cdot, \cdot)$  is continuous, monotone and strictly convex in  $T_{(ij)}$ , implying that we are focusing on situations where congestion effects occur in each link. There is a cost per-unit of infrastructure provided that will represent the cost side of a CBA in our context, but we assumed it null at this point in order to focus on user's benefits. Allowing this cost to be different from zero will made possible to analyze the interaction of first and second best policies in infrastructure provision within the surplus equivalence question (Meléndez-Hidalgo et. al. 2006).

Let us define, for each region  $l \in L$ ,  $\psi_l(S_l)$  as the inverse supply function with associated long-run supply function  $S_l(\psi_l)$ , and  $\theta_l(D_l)$  as the inverse demand function with associated long-run demand function  $D_l(\theta_l)$ . These functions are assumed, without loss of generality, separable in prices and quantities for simplicity in computation of equilibrium and simulations (Friesz et.al. 1983).

### Perfect competition

The competitive SPE conditions compatible with atomistic behavior in production and consumption (Samuelson, 1952) can be written as:

$$\begin{aligned} \text{if } T_{(ij)} > 0, \text{ then } \psi_i(S_i) + c_{(ij)}(T_{(ij)}) &= \theta_j(D_j) && \text{for all } (ij) \in W. \\ \text{if } \psi_i(S_i) + c_{(ij)}(T_{(ij)}) > \theta_j(D_j), \text{ then } T_{(ij)} &= 0 && \text{for all } (ij) \in W. \end{aligned}$$

These conditions state that a shipper or trader will purchase the good in a perfectly competitive market at node  $i$  for the price  $\psi_i(S_i)$ , and will incur an economic price of

<sup>29</sup> Thore (1991) considers transport cost for shipping within a given region.

<sup>30</sup> Following Harker (1985) and Florian and Los (1981),  $c_{(ij)}$  is the economic price (freight rate plus value of level of service) if a transportation firm offers service between  $(ij) \in W$ .

transportation,  $c_{(ij)}(T_{(ij)})$ , for the move of goods from  $i$  to  $j$ . The shipper takes this economic price of transportation as given. If the price he could receive in the perfectly competitive market at region  $j$ ,  $\theta_j(D_j)$ , exceeds the sum of the purchase price and the transportation charges (= *delivered price*), then he will continue to ship the good until the sale price and the delivered price are equal. If the delivered price is greater than the sale price, the shipper will lose money in shipping from  $i$  to  $j$  and hence he will not ship anything between this O-D pair (condition (ii)).

Conditions (i) and (ii) and (1) can be formulated as a complementarity problem, a variational inequality problem or as a simple mathematical programming problem depending on the functional forms and network conditions assumed. In our context the mathematical program describing the decentralized solution can be written as:

$$\text{Max} \quad \sum_{l \in L} \int_0^{D_l} \theta_l(s) ds - \sum_{l \in L} \int_0^{S_l} \psi_l(s) ds - \sum_{(ij) \in W} \int_0^{T_{(ij)}} c_{(ij)}(s, K_{(ij)}^0) ds \quad (3)$$

$$\text{subject to} \quad S_l - D_l + \sum_{i \in L} \sum_{(ij) \in W} T_{(il)} - \sum_{j \in L} \sum_{(ij) \in W} T_{(lj)} = 0 \text{ for all } l \in L$$

$$D_l, S_l \geq 0 \text{ for } l \in L$$

$$T_{(ij)} \geq 0 \text{ for all } (ij) \in W$$

$$M_l^S \leq S_l \leq U_l^S \text{ for all } l \in L;$$

$$M_l^D \leq D_l \leq U_l^D \text{ for all } l \in L;$$

$$M_l^T \leq T_{(ij)} \leq U_l^T \text{ for all } (ij) \in W.$$

where  $M_l^Z, U_l^Z$ , with  $Z = \{D, S\}$ , corresponding to upper and lower bounds on the supplies, demands and O-D flows as discussed in Harker(1986). The formulation in (3) reflects a decentralized initial equilibrium before the increase in capacity  $K_{(ij)}$ , then the 0 superscript in the capacity index.

A distinction should be made here between first and second best policies in the transport sector depending on if congestion charging is in place or not (Williamson et.al., 2001). This will affect the objective function in (3) as well as in subsequent formulations with alternative product market industrial organizations. Is not our aim in this paper to consider optimal policies per-se. In what follows we will ignore any other possible instruments at hand to the social planner for optimizing total welfare, except from congestion taxes. The social planner will either choose between implementing congestion charging in every link of the network, at a rate  $\tau_{(ij)}$ , and a policy of no-intervention at all.<sup>31</sup> In the latter case, as shown in the last element of the objective function in (3), a Wardropian user optimal equilibrium concept for network flows and costs is at stake, i.e. each shipper seeks to minimize its transportation cost.

---

<sup>31</sup> In a latter section when we consider more than one path between origin-destination pairs, these two policy options in transportation markets will clearly correspond to Wardropian System and User Equilibrium, respectively; see Harker (1985) and Fernandez and Friesz (1983). At this point the first-best level of the congestion charge is calculated as is usual in the literature; more explicitly in our context we follow van den Bergh and Verhoef (1996).

In equilibrium used paths between any O-D pair have the same cost and unused paths have costs at least as high (Fisk, 1987). The existence of alternative paths for a given O-D pair is not explicitly considered in the formulation that we are using here for the SPE, and this will be amended later in the path formulation section and incorporated in the numerical simulations section of the paper when discussing transshipment nodes for better representing transportation infrastructure. Even though, it is important to notice that the conservation flow condition in (1) implicitly allows an exporting region to use a “third-region” for conducting its shipments to a final importing region. The third region in that case will be playing the role of a transshipment node (in this case with its own market) and this might lead to more than one shipping paths for a particular O-D pair. At this stage of the paper we just need to notice that this possibility exists and consequently we introduce the Wadropian equilibrium that applies depending on if there is congestion charging in place or not (i.e. user or system equilibrium).

The average cost function in (3) is replaced by the marginal cost function (Beckmann, 1967; Yang and Huang, 1998) when first-best congestion charging is applied, leading to a Wadropian social optimal equilibrium for network flows and costs. The marginal cost function is defined as:

$$c_{(ij)}^{mg}(T_{(ij)}, K_{(ij)}^0) = c_{(ij)}(T_{(ij)}, K_{(ij)}^0) + T_{(ij)} \frac{dc_{(ij)}(T_{(ij)}, \cdot)}{dT_{(ij)}} \quad \text{for all } (ij) \in W$$

Establishing tolls,  $\tau_{(ij)}$ , given by:

$$\tau_{(ij)} = T_{(ij)} \frac{dc_{(ij)}(T_{(ij)}, \cdot)}{dT_{(ij)}} \quad \text{for all } (ij) \in W$$

Consequently the only change in the objective function is to consider an additional (negative) term representing a congestion charge, which is assumed to be totally passed on to the consumers.<sup>32</sup> The mathematical program describing the decentralized solution when congestion charging is practiced will be:

$$\text{Max} \quad \sum_{l \in L} \int_0^{D_l} \theta_l(s) ds - \sum_{l \in L} \int_0^{S_l} \psi_l(s) ds - \sum_{(ij) \in W} c_{(ij)}(T_{(ij)}, K_{(ij)}^0) T_{(ij)} \quad (3b)$$

subject to the same equalities and inequalities. Observe that whereas the objective function in (3) has no economic interpretation, the one in (3b) corresponds to the total social welfare for the economy under analysis.

JD shows that, total welfare changes from a situation with no trade between regions to one with positive trade across regions will correspond to the transport consumers’ surplus resulting in the decentralized solution with positive trade, measuring this surplus based on a derived transport demand. This holds for non-flow dependent transport costs and perfect competition both in production and consumption. When transport cost does depend on the flow, it is straightforward to show that this relationship will continue to

---

<sup>32</sup> For a discussion on congestion charges incidence under imperfect competition in production see Van Dender (2004).

hold if the perfect competition assumption is kept for production and consumption and a complete CBA is implemented (e.g. including congestion taxes revenue changes). We will go into more detail on this relation later in the paper. Before that we discuss how the total social welfare is computed in both the before and after transport-cost-change equilibriums.

Social welfare corresponds to the sum of consumer's surplus and producer's surplus in every region (including transport costs) and in perfect competition ( $SW_c$ ) is computed as follows:

$$\begin{aligned}
 SW_c = & \sum_{l \in L} \int_0^{D_l} \theta_l(s) ds - \sum_{l \in L^I} \theta_l(D_l) S_l - \sum_{l \in L^E} \theta_l(D_l) [D_l - S_l] - \sum_{l \in L^E} \theta_l(D_l) D_l \\
 & + \sum_{l \in L^I} \theta_l(D_l) S_l + \sum_{l \in L^E} \theta_l(D_l) D_l + \sum_{l \in L^I} \theta_l(D_l) [D_l - S_l] - \sum_{l \in L} \int_0^{S_l} \psi_l(s) ds \\
 & - \sum_{(ij) \in W} c_{(ij)}(T_{(ij)}, K_{(ij)}^z) T_{(ij)}
 \end{aligned}$$

with  $L^I$  and  $L^E$  referring to the set of import and export nodes, respectively. The  $SW_c$  reduces to:

$$SW_c = \sum_{l \in L} \int_0^{D_l} \theta_l(s) ds - \sum_{l \in L} \int_0^{S_l} \psi_l(s) ds - \sum_{(ij) \in W} c_{(ij)}(T_{(ij)}, K_{(ij)}^z) T_{(ij)} \quad (4)$$

which is gross benefits to consumers minus total costs including the cost incurred in transportation.

When there is congestion charging the government surplus will become explicit (non-zero) in the social welfare function.<sup>33</sup> In perfect competition the difference between prices in each node will match the sum of average costs plus the congestion charge,  $\tau_{(ij)}$ , then the social surplus for the decentralized solution with congestion charging will be:

$$SW_c = \sum_{l \in L} \int_0^{D_l} \theta_l(s) ds - \sum_{l \in L} \int_0^{S_l} \psi_l(s) ds - \sum_{(ij) \in W} c_{(ij)}(T_{(ij)}, K_{(ij)}^0) T_{(ij)} - \sum_{(ij) \in W} \tau_{ij} T_{(ij)} + \sum_{(ij) \in W} \tau_{ij} T_{(ij)} \quad (5)$$

Expression (5) is equivalent to (4).

#### *Perfect collusion (spatial monopoly without resale)*

Takayama and Judge (1971) formulated their model in a simple network where the monopolist takes as given the transport costs, e.g. transport rate. Harker (1986) shows how a different interpretation of the transportation costs leads to two distinct models of spatial monopolies. In the first case, it is recognized that in most situations the producing firm will buy the transportation service from a motor carrier, railroad, or other carrier. Under these conditions producers will take the economic price of

transportation as given when deciding how much to produce and send to each market.<sup>34</sup> The following mathematical program results:

$$\text{Max} \quad \sum_{l \in L} \theta_l (D_l) D_l - \sum_{l \in L} \int_0^{S_l} \psi_l(s) ds - \sum_{(ij) \in W} \int_0^{T_{(ij)}} c_{(ij)}(s, K_{ij}^0) ds \quad (6)$$

subject to (1), and  $D_l, S_l \geq 0$  for all  $l \in L$ , and  $T_{(ij)} \geq 0$  for all  $(ij) \in W$ .

From the Kuhn-Tucker conditions of this problem we can derive the transport market equilibrium and consequently compute the transportation consumption surplus. These conditions are necessary and sufficient and letting  $\pi_l$  denote the dual variable of constraint (1) we have:

$$\begin{aligned} (\theta_l + D_l \theta'_l - \pi_l) D_l &= 0 && \text{for all } l \in L \\ \theta_l + D_l \theta'_l - \pi_l &\leq 0 && D_l \geq 0 \\ (-\psi_l + \pi_l) S_l &= 0 && \text{for all } l \in L \\ -\psi_l + \pi_l &\leq 0 && S_l \geq 0 \\ (-c_{(ij)} + \pi_j - \pi_i) T_{(ij)} &= 0 && \text{for all } (i, j) \in W \\ -c_{(ij)} + \pi_j - \pi_i &\leq 0 && T_{(ij)} \geq 0 \end{aligned}$$

what these conditions imply in terms of trade is that if there is flow between region  $i$  and  $j$ , then the private marginal cost of transporting one unit ( $c_{(ij)}$ ) plus the marginal production cost in  $i$  ( $\psi_i$ ) equals marginal revenue ( $\theta_j + D_j \theta'_j$ ). If these conditions do not hold for a particular O-D pair, then there is not trade in that particular pair. If there is congestion charging in practice, the firm's profit (or cartel) maximization problem will be written as:

$$\text{Max} \quad \sum_{l \in L} \theta_l (D_l) D_l - \sum_{l \in L} \int_0^{S_l} \psi_l(s) ds - \sum_{(ij) \in W} c_{(ij)}(T_{(ij)}, K_{(ij)}^0) T_{(ij)} \quad (7)$$

subject to (1) and non-negativity constraints. In both (8) and (9) we are considering  $c_{(ij)}$  as the average cost price of transport. The Kuhn-Tucker conditions in this case are:

$$\begin{aligned} (\theta_l + D_l \theta'_l - \pi_l) D_l &= 0 && \text{for all } l \in L \\ \theta_l + D_l \theta'_l - \pi_l &\leq 0 && D_l \geq 0 \\ (-\psi_l + \pi_l) S_l &= 0 && \text{for all } l \in L \\ -\psi_l + \pi_l &\leq 0 && S_l \geq 0 \\ (-c_{(ij)} - T_{(ij)} c'_{(ij)} + \pi_j - \pi_i) T_{(ij)} &= 0 && \text{for all } (i, j) \in W \\ -c_{(ij)} - T_{(ij)} c'_{(ij)} + \pi_j - \pi_i &\leq 0 && T_{(ij)} \geq 0 \end{aligned}$$

<sup>34</sup> Florian and Los (1982) discuss in much detail the different interpretations possible for the industrial organization of the transport sector.

The only difference here is that instead of the marginal private cost of transportation is the marginal “social” cost the one used in the previous conditions.

Concerning the social welfare, in the first formulation it will correspond to the sum of consumer’s surplus and firm’s profits minus transportation costs for each regional market, while in the case of congestion charging we will explicitly add the government surplus although as before, it will cancel out against toll payments by transporters. The social welfare function under monopoly will have the same reduced form as in perfect competition ( $SW_m$ ):

$$SW_m = \sum_{l \in L} \int_0^{D_l^e} \theta_l(s) ds - \sum_{l \in L} \int_0^{S_l^e} \psi_l(s) ds - \sum_{(ij) \in W} c_{(ij)}(T_{(ij)}^e, K_{(ij)}^0) T_{(ij)}^e \quad (8)$$

which is equivalent to (5). For the case where congestion charging is in place a parallel case also be drawn with respect to the competitive situation. The addition of the government surplus will result in an expression of welfare equal to (6).

### Cournot-Nash oligopoly

The model we implement here follows closely Harker (1986). If  $Q$  denotes the set of firms operating in the market and each firm  $q \in Q$ ’s control only one production site ( $Q = L$ ). The total amount demanded in region  $l \in L$  is given by  $D_l$ . Defining  $D_{lq}$  as the amount shipped by firm  $q$  to region  $l$  (or the amount demanded by the consumers in region  $l \in L$  from firm  $q$ ), and  $\tilde{D}_{lq}$  as the amount supplied by all other firms to region  $l \in L$ :

$$\tilde{D}_{lq} = \sum_{j \in Q, j \neq q} D_{lj}$$

and

$$D_l = \sum_{j \in Q} D_{lj} \quad (9)$$

we can defined a spatial Cournot-Nash equilibrium as the solution, for every firm, of the following programming program:

$$\text{Max} \quad \sum_{l \in L} \theta_l(D_{lq} + \tilde{D}_{lq}) D_{lq} - \int_0^{S_q} \psi_q(s) ds - \sum_{(qj) \in W} \int_0^{T_{(qj)}} c_{(qj)}(s, K_{(qj)}^0) ds \quad (10)$$

subject to an optimal strategy vector  $x_q$ , followed by all other firms (including supplies, demands and transport flows). The amount supplied by all other firms to region  $l \in L$ ,



$\tilde{D}_{lq}$ , is taken as given in the perspective of a particular firm.<sup>35</sup> At this point, we also assume  $c_{(ij)}(T_{(ij)})$  is given, even in the presence of congestion charging. This last assumption could be seen controversial when a more realistic view of the interaction shipper-carrier is considered in a Cournot-Nash environment since a partial market power should be recognized for either size in this context. If for example, transport services are produced under oligopoly conditions then in the presence of congestion a partial internalization of the externality created when transporting using a fixed capacity should be recognized. This is precisely the point raised recently for airline transportation in Brueckner (2004) and Verhoef and Pels (2004).

For the mathematical program formulation in (13) there are associated Kuhn-Tucker conditions similar to the ones obtained for the monopoly case. Important insight can be obtained from these conditions:

$$\begin{aligned}
 (\theta_l(\tilde{D}_{lq} + D_{lq}) + D_{lq} \partial \theta_l(\tilde{D}_{lq} + D_{lq}) / \partial D_{lq} - \pi_l) D_{lq} &= 0 && \text{for all } l \in L \\
 (\theta_l(\tilde{D}_{lq} + D_{lq}) + D_{lq} \partial \theta_l(\tilde{D}_{lq} + D_{lq}) / \partial D_{lq} - \pi_l) &\leq 0 && D_{lq} \geq 0 \\
 (\theta_q(\tilde{D}_{lq} + D_{qq}) + D_{qq} \partial \theta_q(\tilde{D}_{lq} + D_{qq}) / \partial D_{qq} - \pi_q) D_{qq} &= 0 && \text{for } q \\
 (\theta_q(\tilde{D}_{lq} + D_{qq}) + D_{qq} \partial \theta_q(\tilde{D}_{lq} + D_{qq}) / \partial D_{qq} - \pi_q) &\leq 0 && D_{qq} \geq 0 \\
 (-\psi_q + \pi_q) S_q &= 0 \\
 -\psi_q + \pi_q &\leq 0 && S_q \geq 0 \\
 (-c_{(qj)} + \pi_j - \pi_q) T_{(qj)} &= 0 && \text{for all } (q, j) \in W \\
 -c_{(qj)} + \pi_j - \pi_q &\leq 0 && T_{(qj)} \geq 0
 \end{aligned}$$

The first two conditions imply that if there is demand in a particular region for the product of firm  $q$ ,  $\pi_l$  will equal the marginal revenue for firm  $q$  in that region. Similarly conditions three and four imply that if there is demand in the region that the firm is located, then  $\pi_q$  will equal the marginal revenue for firm  $q$  in its location. The last four conditions concern costs of production and transportation. Conditions six and seven imply that if there is production,  $\pi_q$  will equal the marginal cost of production whereas the last two conditions state that if there is flow between region  $j$  and the production site of firm  $q$  then the cost of transportation plus the marginal cost of production will equal the marginal revenue for firm  $q$  in region  $j$ . An important distinction with respect to the perfect collusion case is that the marginal revenue functions here are based on a residual demand, instead of the total demand in a particular market. This residual demand is the part of total demand that firm  $q$  considers it is facing, after subtracting the expectation of supply for that market from other firms.

---

<sup>35</sup> Equilibration algorithms for oligopoly models usually employ diagonalization/relaxation algorithms. These algorithms applied to oligopoly problems have an interesting interpretation as a Cournot expectation dynamic process. This process assumes that each player (firm) establish its strategy (production level) by trying to maximize its individual profit, considering that the other players will set their own strategies as the same as the last round. After all the firms make their choice, the game moves to another state and the firms play again. This process continues until no firm can increase its profits. The Cournot expectation process can be interpreted as a Jacoby method.

Concerning total welfare computations a similar procedure as the one followed for the perfect collusion case applies here. Total social welfare will depend again on the congestion pricing policy but in general will consist of the sum of consumer's surplus and firm's profits (including transport costs) over all regions.

$$\begin{aligned}
 SW_o = & \sum_{l \in L} \int_0^{D_l} \theta_l(s) ds - \sum_{l \in L} \theta_l(D_l) D_l + \sum_{q \in Q} \sum_{l \in L} \theta_l(D_l) D_{lq} - \sum_{q \in Q} \int_0^{S_{lq}} \psi_{lq}(s) ds \\
 & - \sum_{q \in Q} \sum_{(qj) \in W} c_{(qj)}(T_{(qj)}, K_{(qj)}^0) T_{(qj)}
 \end{aligned} \tag{11}$$

which using (11) reduces to:

$$= \sum_{l \in L} \int_0^{D_l} \theta_l(s) ds - \sum_{q \in Q} \int_0^{S_{lq}} \psi_{lq}(s) ds - \sum_{(ij) \in W} c_{(ij)}(T_{(ij)}, K_{(ij)}^0) T_{(ij)} \tag{12}$$

Following a similar path of argumentation as in the cases of perfect competition and perfect collusion, a similar expression can be shown to apply for the case where congestion pricing is in practice. A final important distinction to notice here is that the level of total supply will lie between these two extremes and it can be shown (Haurie and Marcotte, 1996) that in the limit, when the number of firms goes to infinity, it will coincide with the perfect competition production level.

*Path formulation: trans-shipment nodes*

In this section we discuss how the previous model formulation changes when trans-shipment nodes are explicitly considered. A variable path formulation explicitly considers trans-shipment nodes which better represent certain types of transport infrastructure. The network is again a finite-directed graph,  $G[N, A]$ , with  $N$  and  $A$  denoting the full set of nodes and arcs respectively. The set of centroids  $L$  is a subset of  $N$ . Thus, the network contains nodes that are neither origins nor destinations, but represent transportation facilities such as rail yards or ports (Harker, 1986). The indices  $a$  and  $p$  refer respectively to an arc or link and a path in the network. The indices  $i, j, k$ , and  $l$  refer to nodes of the network and  $P_{ij}$  denote the set of all paths connecting node  $i$  to node  $j$ , consequently  $p \in P_{ij}$  is a particular path between regions  $i$  and  $j$ . For  $\delta_{ap} = 1$  link  $a$  is contained in path  $p$  while  $\delta_{ap} = 0$  otherwise. The flow on link  $a$  is represented by  $f_a$  while  $h_p$  is the flow on path  $p$ ; consequently  $f_a = \sum_{p \in P_{ij}} \delta_{ap} h_p$ . The average (unit) cost function of transportation on arc  $a$  will be denoted by  $c_a(f)$ , while the average cost on path  $p$  is  $C_p(h) = \sum_a \delta_{ap} c_a$ .

The equilibrium conditions change according to the product competition assumed. For instance, for the perfect competition case  $\pi_l$  denote the commodity price at node (market)  $l$ ,  $D_l(\pi)$  is the commodity demand at region  $l$ ,  $S_l(\pi)$  is the commodity supply at region  $l$  and  $f, D, S, c$  and  $\pi$  are the full row vectors of link flows, demands, supplies, unit link costs and prices. In a particular network with  $m$  arcs and  $n$  nodes (regions) a

flow pattern  $(f, \pi)$  satisfying the following conditions is a competitive spatial price equilibrium:

$$h_p [C_p(h) + \pi_i - \pi_j] = 0 \quad \forall (i, j, p \in P_{ij}) \quad (a)$$

$$C_p(h)_p + \pi_i - \pi_j \geq 0 \quad \forall (i, j, p \in P_{ij}) \quad (b)$$

$$D_l(\pi) - S_l(\pi) + \sum_k \sum_{p \in P_k} h_p - \sum_k \sum_{p \in P_{kl}} h_p = 0 \quad \forall l \quad (c)$$

$$f_a - \sum_P \delta_{ap} h_p = 0 \quad \forall a \quad (d)$$

$$h \geq 0, \pi \geq 0 \quad (e)$$

Conditions (a) and (b) consist of a generalization of the spatial price equilibrium conditions discussed in the previous formulation based on Samuelson (1952). Condition (a) implies that for utilized paths between a given origin-destination pair delivered commodity prices equals local ones. Condition (b) states that paths for which delivered price exceeds local price will not be utilized. The flow conservation condition is stated in (c); (d) is the definition of flow already given before while (e) corresponds to non-negativity conditions. Conditions (a) to (e) can also be used to represent multiple-mode and multiple-commodity equilibrium problems using the device of a multi-copy network originated in Aashtiani (1979). Similar modifications can be performed to cast the two other product competition arrangements in a path-formulation.

This closes the formalization of the SPE previously discussed in a graphical manner. In the next section the formalization of the models is employed to conduct two simulation exercises which illustrate and complement the previous discussion. The idea there is to construct two simple examples where the same conditions (i.e. parameters) holds for both cases except for the transportation network employed. Similar trade flow paths and magnitudes are obtained but it is shown that the different between infrastructure improvements benefits can be quite significant despite the similitude in demand and supply primitives. The shape of the transport network drives the results.

#### 4. Simulation results

In this section we use numerical simulations to illustrate and complement the main conceptual results already provided in the paper. A three region economy embedded in two different transport networks is the workhorse employed to study the different impacts arising from an infrastructure investment under alternative competition arrangements. The two networks differ on the existence of a transshipment node. In both network cases the supply-demand nodes are characterized by the same set of parameters and the cost link parameters are such that similar patterns of trade are obtained. This is in order to capture in our results the distinguish effects arising from the differences in

transport network shape. For both types of networks the following functional forms are used:

$$\Psi_l(S_l) = \alpha_l + \beta_l S_l \quad (\text{Cost function})$$

$$\Theta_l(D_l) = \rho_l - \eta_l D_l \quad (\text{Demand function})$$

$$c_a(f_a) = \kappa_a + v_a f_a^2 \quad (\text{Transport Cost function per link})$$

where  $\alpha_l, \beta_l, \rho_l, \eta_l, \kappa_a$  and  $v_a$  are constants. The transport cost function is interpreted as average private costs (taking into account level of service) and then expressions for the total costs and social marginal costs can be obtained from it.

Table 1a shows the calibration of parameters for the demand and supply in the two network cases considered. These values together with the transport network parameters generate a certain pattern of trade across regions.

Table 1: Parameters for Production and Consumption Functions per Region.

Region $l \in L$	$\alpha$	$\beta$	$\rho$	$\eta$
1	0.1	0.05	1.9	0.02
2	0.2	0.04	2.7	0.001
3	0.15	0.03	3.0	0.03

The first type of network extends the two region economy previously analyzed with a third production-consumption node and two related transport links. Again we are here considering a one-good economy. This case has not been analyzed in the literature and as an extension of the previous case, allows us to study network issues in the simplest setting possible. Table 2 shows the parameters for the transport cost function.

*First network*

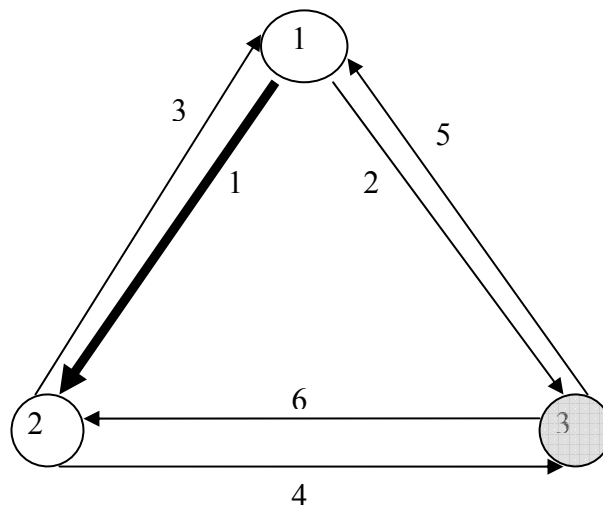

An important issue raised by this case is that whenever there is a change in the cost of transporting through a particular link, the demand on other links will change resembling a general equilibrium effect in the transport markets. This interaction has been addressed recently in a different framework by Kidokoro (2003) and is included in the results shown later in Table 3 when computing the change in TCS in all links. For the cases of monopoly and oligopoly “indirect benefits” are present and captured by a level of the usual multiplier different that one. Under perfect competition the ratio of social welfare changes to user’s benefits (i.e. multiplier) takes always a value of one, both for the case of no tolling and optimal tolling. For the latter, the change in congestion charges revenue adds up with the usual transport benefits.

Table 2: Parameters for Transportation Functions per Link.

Arc $a \in A$	$\kappa$	$v$
1	0.1	0.04
2	0.2	0.04
3	0.1	0.02
4	0.3	0.03
5	0.1	0.01
6	0.4	0.08

A reduction in 10% on the capacity related parameter ( $v$ ) in link 1 is the infrastructure improvement scenario considered; starting from the initial level in Table 2. Trade flows differ for the different competition arrangements. Under perfect competition trade flows are positive in link 1, 2 and 6 for all equilibriums. Region 1 exports to both regions 2 and 3; region 3 exports to region 2 and imports from region 1. Region 2 imports from the other two regions. This structure of trade includes route choice for region 1 exports to region 2. Is already established in the literature that a model with this features will show uniqueness of equilibrium only at the level of link flow, but multiple equilibria will arise at the level of path flow (Fernandez and Friesz, 1982). Taking this into account in the computation of changes in TCS implies calculating benefits at the level of link flow. For the monopoly case trade goes from regions 1 and 3 to region 2. Finally, when producers interact in a Cournot-Nash fashion the trade flows resemble the pattern of the perfect competition case, but in addition there is trade from region 3 to region 1. This extra flow is implying that there is two-way trade between these two regions. Table 1 show the results for the three alternative competition assumptions in production.

Since we assume either optimal or zero toll levels in all links, transport benefits for the perfect competition case (CSPE) will match economy-wide welfare changes in both cases. For the perfect collusion case the situation is quite different. Without tolls transport benefits overestimate the economy-wide effects with the gap explained both by profits made on the extra units (both imported and exported) and the net loss in consumer surplus for these extra units transferred from the exporting the to importing region. As shown in Table.3, as the link 1 capacity expands the overestimation persists when optimal tolling is implemented but turns into underestimation when no tolling is practised. This is so because even though the presence of congestion externalities affects welfare negatively, the fact that there is not toll allows the monopolist to reach output levels which bring profit and net consumer surpluses effects that compensate that

overall compensate this externality. On the other hand, when congestion is optimal charged, the externality is eliminated but the level of output in which the monopolist is manoeuvring is such that the net profit effects is compensated by a negative net consumers surplus effect, then the multiplier is always below one. The Cournot-Nash case also shows overestimation of economy-wide benefits and under the parameter values we chose it is more severe than the perfect collusion case. The interesting point here is that under the same functional form for supply and demand, the strategic interaction among firms can create significant negative indirect effects even when congestion is charged. As capacity expands to reach a very small value for  $v_1$ , eventually the gap between both multipliers shrink but there are still negative indirect benefits (i.e. disbenefits).

Table 3: Results from a three node network without transshipment nodes.

Transport Parameters		Multipliers					
		CSPE		MONOP		OLIGOP	
Fixed	Variable	No Tolling	Optimal Tolling	No Tolling	Optimal Tolling	No Tolling	Optimal Tolling
0.1	0.04						
0.1	0.036	1.000	1.000	0.983	0.946	0.456	0.723
0.1	0.032	1.000	1.000	1.001	0.949	0.490	0.728
0.1	0.029	1.000	1.000	1.017	0.952	0.523	0.734
0.1	0.026	1.000	1.000	1.032	0.955	0.553	0.739
0.1	0.023	1.000	1.000	1.048	0.959	0.587	0.746
0.1	0.021	1.000	1.000	1.061	0.963	0.617	0.751
0.1	0.019	1.000	1.000	1.073	0.966	0.643	0.757
0.1	0.017	1.000	1.000	1.086	0.970	0.671	0.763
0.1	0.015	1.000	1.000	1.099	0.975	0.702	0.770
0.1	0.0135	1.000	1.000	1.112	0.980	0.731	0.776
0.1	0.005						
0.1	0.0045	1.000	1.000	1.202	1.044	0.776	0.853

The previous network was the simplest possible extension from J-D and J-D and F when considering congestion. Even in this network there is route choice in the perfect competition case when trade goes from region 1 to region 2 directly but also through region 3. Route choice is not possible in the case of monopoly or Cournot-Nash oligopoly. The next network structure model explicitly a trans-shipment (without route choice) in order to compare the magnitude of the multiplier arising simply from a different network structure.

Second network

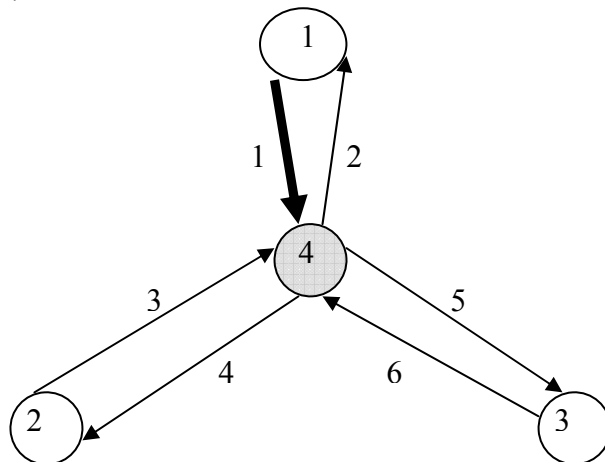

The second network corresponds to a case where all trade flows have to arrive first to a consolidation point (trans-shipment node), where network resources are shared between shippers. Table 4 shows the parameters for the transport cost function in each link. The infrastructure improvement is again in link 1. The pattern of trade is similar to the one discussed for the previous network. A distinctive situation occurs for the case of monopoly and Cournot-Nash because trade goes from regions 3 and 1 to region 2, implying that the last link to reach region 2 is shared by these two flows. Once, the infrastructure is improved in link 1 this generate negative spillover effects to the flow going from 3 to 4. In an extreme situation this can lead to negative social welfare changes resembling a Braess paradox type of phenomena at the level of the entire economy.<sup>36</sup> The sign of the indirect benefits change for the monopoly case and the magnitude of the extra benefits (above the usual transport benefits) is considerable. Again, this benefits are higher without tolling because due to the demand and supply schedules parameters, the monopolist without congestion charging can reach output level where the net consumer surpluses effects turns out to be positive and adds up with the profits effect.

Table 4: Parameters for Transportation Functions per Link.

Arc $a \in A$	$\kappa$	$\nu$
1	0.05	0.02
2	0.05	0.01
3	0.05	0.01
4	0.07	0.05
5	0.03	0.01
6	0.02	0.01

Table 5: Results from a three node network with one transshipment.

Transport Parameters		Multipliers					
		CSPE		MONOP		OLIGOP	
Fixed	Variable	No Tolling	Optimal Tolling	No Tolling	Optimal Tolling	No Tolling	Optimal Tolling
0.05	0.02						
0.05	0.018	1.000	1.000	4.223	2.090	0.406	0.513
0.05	0.016	1.000	1.000	4.010	2.130	0.442	0.518
0.05	0.014	1.000	1.000	3.805	2.178	0.475	0.523
0.05	0.0126	1.000	1.000	3.637	2.229	0.507	0.528
0.05	0.011	1.000	1.000	3.491	2.220	0.535	0.533
0.05	0.01	1.000	1.000	3.368	2.207	0.560	0.538
0.05	0.009	1.000	1.000	3.273	2.247	0.579	0.542
0.05	0.008	1.000	1.000	3.178	2.294	0.735	0.546

In the oligopoly case, considerable indirect effects arise. Again, as congestion is realised through capacity improvements, the multipliers increases. Under the parameter chosen the strategic interaction across firms is such that the re-composition of market shares and the net consumer welfare effects compensate the usual transport benefits.

<sup>36</sup> Venables (1999) discuss this possibility for the case of transport market with a similar transport network shape.

## 5. Conclusions

Our aim in this paper has been to study in more detail the difference in benefits measures arising from an infrastructure improvement employing a spatial price equilibrium framework, originating in Samuelson (1952). Previous contributions had looked at the topic in a simplified fashion assuming extreme product competition arrangements and network environments. We contribute with this literature by extending these previous contributions in several ways. First, apart from the usual perfect competition assumption we consider monopolistic behaviour across regions without the possibility of resale and Cournot-Nash interaction across regions-firms. Additionally we employ flow depend transport cost functions and allow for the existence of optimal tolling or no tolling at all. Finally, we explain in detail the formalization of the models to more than two regions and complex networks and illustrate our main points with numerical simulations in a three region network with and without transshipment nodes.

Our main contribution is to disentangle the relationship between economy-wide changes and transport users' benefits under spatial monopoly without resale and spatial Cournot-Nash firm interaction. For the former case, the relationship is clear and driven by the net effect of net consumer surpluses changes and net profit changes. On the contrary, for the latter there is no clear connection that we can derive between transport users' benefits and welfare changes because the strategic interaction between firms makes difficult the measurement of the transport benefits, as compared with the perfect competition and collusion cases. In the last section, some illustrative numerical simulations are shown which lead us to conclude that the sign and magnitude of the indirect benefits are significantly influenced by the shape of the transportation network.

## References

- Aashtiani, H. Z. and Magnanti, T. L. (1981) "Equilibria on a congested transportation network" *SIAM Journal on Algebraic and Discrete Methods* 2, pp. 213–226.
- Brander, J. A. (1981) "Intra industry trade in identical commodities" *Journal of International Economics* 11, pp. 1–14.
- Brander, J. and Krugman, P. (1983) "A 'Reciprocal Dumping' Model of International Trade" *Journal of International Economics*, 15, pp. 313-321.
- Beckmann, M., McGuire, C. B. and Winsten, C. B. (1956) *Studies in the economics of transportation*. Yale University Press, New Haven, Connecticut; also published as Rand-RM-1488-PR, Rand Corporation, Santa Monica, CA, May 12, 1955.
- Brueckner, J. (2002) "Airport congestion when carriers have market power", *American Economic Review*, 92, 5, pp. 1357-1375.
- Cremer, H., Farid, G. and Laffont, J. J. (2003) "Access to Pipelines in Competitive Gas Markets", *Journal of Regulatory Economics*, Vol. 24, No. 1, pp. 5-33.
- Dafermos, S. and Nagurney, A. (1985) "Isomorphism between spatial price and traffic equilibrium models". *Lefschetz Center for Dynamical Systems Report No. 85-17*, Division of Applied Mathematics, Brown University, Providence, Rhode Island.
- Enke, S. (1951) "Equilibrium among spatially separated markets: Solution by electronic analogue", *Econometrica* 10, pp. 40–47.
- Fernández, J. L. and Friesz, T. L. "Equilibrium Predictions in Transportation Markets: The State of the art". *Transportation Research*, Vol. 17B, No. 2, pp. 155-172, 1983.
- Friesz, T. L. (1985) "Transportation network equilibrium, design and aggregation: Key developments and research opportunities." *Transportation Research., Part A*, 19A(5–6), pp. 413–427.



- Friesz, T. L., Bernstein, D., Smith, T. E., Tobin, R. L. and Wie, B.W. (1993) "A variational inequality formulation of the dynamic network user equilibrium problem", *Operations Research* 41, pp. 179–191.
- Friesz, T. L., Bernstein, D., Mehta, J., Tobin, R. L. and Ganjalizadeh, S. (1994) "Day to day dynamic network disequilibrium and idealized traveler information systems". *Operations Research* 42, pp. 1120–1136.
- Friesz, T. L., Harker, P. T. and Tobin, R. L. (1984) "Alternative algorithms for the general network spatial price equilibrium problem". *Journal of Regional Science* 24, pp. 475–507.
- Friesz, T. L., Tobin, R. L. Smith, T. E. and Harker, P. T. (1983) "Anonlinear complementarity formulation and solution procedure for the general derived demand network equilibrium problem." *Journal of Regional Science* 23, pp. 337–359.
- Florian, M. and Los, M. (1982) "A new look at static spatial price equilibrium models". *Regional Science and Urban Economics* 12, pp. 579–597.
- Friesz, T. L., Tobin, R. L., Smith, T. E. and Harker, P. T. (1983) "A nonlinear complementarity formulation and solution procedure for the general derived demand network equilibrium problem." *Journal of Regional Science* 23, 3, pp. 337–59.
- Harker, P. (1986) "Alternative models of spatial competition." *Operations Research*, 34, pp. 410-425.
- Hashimoto, H. (1995) "A Spatial Nash Equilibrium Model", in: P. Harker, ed., *Spatial Price Equilibrium: Advances in Theory, Computation and Application* Springer-Verlag, 1995.
- Haurie, A. and Marcotte, P. (1985) "On the relationship between Nash and Wardrop equilibrium" *Networks* 15, pp. 295–308.
- Jara-Díaz, S. R. (1986) "On the relation between users' benefits and the economic effects of transportation activities", *Journal of Regional Science*, 26(2), pp. 379-391.
- Jara-Díaz, S. R. and Friesz, T. L. (1982) "Measuring the benefits derived from a transportation investment," *Transportation Research B*, 16B, pp. 57-77.
- Kanemoto, Y. and Mera, K., (1985) "General Equilibrium Analysis of the Benefits of Large Transportation Improvements," *Regional Science and Urban Economics* 15, pp. 343-363.
- Kidokoro, Y. (2003) "Cost-Benefit Analysis for Transport Networks -Theory and Applications", *Journal of Transport Economics and Policy*. Journal of Transport Economics and Policy, Volume 38, Number 2, pp. 275-307(33).
- Melendez-Hidalgo, J., Rietveld, P. and Verhoef, E. (2003) "Transport Infrastructure, Spatial General Equilibrium and Welfare" working paper VU.
- Melendez-Hidalgo, J., Rietveld, P. and Verhoef, E. (2006) "On the Benefits from Transport Infrastructure Investment in a Spatial Oligopoly", working paper VU.
- Mohring, H. (1976) *Transportation Economics*, Ballinger Publishing Co.
- Nagurney, A. (1993) *Network economics: a variational inequality approach*. Kluwer Academic Publishers, Boston, Massachusetts.
- Neuburger, H. (1971) "User benefit in the evaluation of transport and land use plans," *Journal of Transport Economics and Policy*, 5, pp. 52-75.
- Newbery (1998) *Efficiency Benefits of transport cost reductions*, report to SACTRA.
- Pels, E. and Verhoef, E. (2004) "The economics of airport congestion pricing", *Journal of Urban Economics*, 55, 2, pp. 257-277.
- SACTRA (1999) Standing Advisory Committee on Trunk Road Assessment: *Transport and the Economy*.
- Samuelson, P. A. (1952) "Spatial price equilibrium and linear programming" *American Economic Review*, Vol.42, pp. 283-303.
- Samuelson, P. A. (1948) "International trade and the equalization of factor prices." *The Economic Journal*, Vol. 58 (June), pp. 163-184.
- Samuelson, P. A. (1962) "The gains from international trade once again." *Economic Journal*. Vol.72 (December), pp. 820-29.
- Schotchmer, S. and Thisse, J. F. (1992) "Space and competition: a puzzle", *Annals of Regional Science* 26, pp. 269-286.
- Sheppard, E. and Curry, L. (1982) "Spatial price equilibria" *Geographical Analysis* 14, pp. 279–304
- Takayama, T. and Judge, G. G. (1964) "Equilibrium among spatial separated markets: A reformulation". *Econometrica*, 32, pp. 510-524.
- Takayama, T. and Judge, G. G. (1971) *Spatial and temporal price and allocation models*. Amsterdam: North-Holland.
- Takayama, T. and Woodland, A. (1970) "Equivalence of price and quantity formulations of spatial equilibrium: purified duality in quadratic and concave programming". *Econometrica* 38, pp. 889-906.

- Thore, S. (1991) *Economic logistics: The optimization of spatial and sectoral resource, production, and distribution systems*. New York: Quorum Books.
- Tinbergen, J. (1957) "The appraisal of road construction: two calculation schemes" *Review of Economics and Statistics* 39, pp. 241-249.
- Tobin, R. L. and Friesz, T. L. (1983) "Formulating and solving the spatial price equilibrium problem with transshipment in terms of arc variables". *Journal of Regional Science* 23, 2, pp. 187-98.
- van den Bergh, J C. J. M., Nijkamp, P. and Rietveld, P. ed. (1999) *Recent advances in spatial equilibrium modelling: Methodology and applications*. New York: Springer.
- van Dender, K. (2005) "Duopoly prices under congested access", *Journal of Regional Science*, 45, 2, pp. 343-362.
- Venables, A. and Gasiorek, M. (1998) *The Welfare Implications of Transport improvements in the Presence of Market Failure*, report to the Standing Advisory Committee on Trunk Road Assessment. UK.
- Waquil, P. D. and Cox, T. L. (1995) *Spatial equilibrium with intermediate products: Implementation and validation in MERCOSUR*. Staff Paper Series, Department of Agricultural Economics, University of Wisconsin – Madison, USA.
- Yang, H. and Huang, H. J. (1998) "Principle of marginal-cost pricing: how does it work in a general road network?" *Transportation Research* 32A, pp. 45-54.